

ZenAire

; ADDG\$8: ✕C< ~J C✕ H

✕HI 6AA6I ✕C~/ ~DE: G6I ✕C~B 6CJ 6A

Thank you for choosing ZenAire!

Air conditioning facilities are valuable products. In order to protect your legitimate rights and interests, please make sure that the installations are done by professional technicians. This manual is a general-purpose version for the conditioning systems manufactured by our CO., the one that you have chosen might be a little different in appearance from the ones described in the manual. But these differences will not have any impacts upon your operation and use of the system.

Please read the manual carefully before you operate the system and check to see if the model is identical to the one you have purchased, keep the manual properly in case you might refer to it in the future.

CONTENTS	PAGE
NOTICES TO USERS	1
PARTS NAME AND FUNCTION	5
INTRODUCTION OF REMOTE CONTROLLER	6
PREPARATIONS FOR INSTALLATION	9
INSTALLATION OF THE UNIT	14
SYSTEM CHECK AND TRIAL RUN	23
MAINTENANCE AND UPKEEP	25
TROUBLESHOOTING	27
ELECTRIC WIRING	30

NOTICES TO USERS

1. 1 Safety Notices

" Important Safety Information " affords very important points about how to operate the unit safely. To prevent injury to the user or other people and property damage, the following instructions must be followed. Incorrect operation due to ignoring of instructions may cause harm or damage.

The safety precautions listed here are divided into two categories. In either case, important safety information is listed which must be read carefully.

WARNING



Failure to observe a warning may result in serious injury, grave accidents even death.

CAUTION



Failure to observe a caution may lead to injury or damage to the equipment.

Please read the mark of the unit carefully .If you detect any abnormality, such as abnormal noise, smell, fog, temperature rise, creepage, fire and so on; Please turn off the power supply immediately and call your dealer or local service center for instructions. Do not repair the unit by yourself. If necessary, call the local fire department or Emergency department for help.



WARNING

1. Never install the unit by yourself and call the professionals from distributor or maintenance center for installation, or it may lead to accidents and affect the performance of usage .
2. Be sure to install leakage protection switch.
If not installation leakage protection switch, may cause the accident of getting an electric shock etc .
3. The outdoor unit should be installed on the firm level reliably.
4. Must keep the noncongestion that drain off water, otherwise the condensate will be damaged your furniture, electric devices, etc.
5. Make sure that the air conditioner is grounded unflinching, or it may cause an electric shock .
6. Forbid installing it in the places where there might be leakage of combustible gases , full of oil or saliniferous places such as seaside.

7. If the unit will be idle for a long time, disconnect the power to avoid of accidents .
8. The unit shall be equipped with special power supply switch and power line to avoid of sharing the same power line with other devices. Besides, it adopts the stated- cross-section wire to supple the power, matching with the corresponding breaker(with creepage protect function) .
9. The unit is connected with the stated-cross-section earth wire, which is grounded safely and is not allowed to be connected with the gas pipe, water pipe, lightning conductor or the telephone earth wire in order to avoid of electric shocks.
10. Never stop the operation of the unit by pulling out the power supply line in order to avoid of electric shocks or fire hazards .



CAUTION

1. Do not put your hands or sticks into the air vents . As the fan running with high speed will hurt you.
2. Keep the electric control system from damp to avoid of circuit-short or damage of unit .
3. When opening the grille, you cannot increase the external force of pressing down, otherwise the rotating buckle may break.
4. After cleaning the filter screen, install the air filter screen quickly .It is not allowed to operate the unit without the air filter screen which may get the poor performances.
5. When there are old men, children and patient in the room, please adjust the room temperature properly.
6. If the unit is interrupted by the lightning or other electromagnetic radiation, cut off the power, restart the unit after eliminating that factors.
7. Do not clog the air inlet and outlet of the unit.
8. Never use the fuse with incorrect capacity or iron or copper wires for fuse .
9. Keep the unit off the places where might happen fire hazards .Pull out the power plug immediately and put down the fire with fire extinguisher result from circuit-short.
10. Cut off the power supply before servicing.
11. Do not touch the pipe on the exhaust side, because the temperature may be above than 100℃, so it may result in scald.
12. Do not touch the fin and sharp edge which will hurt you.
13. Do not move the unit randomly without professional guidance, otherwise it may cause the damage of the unit .

14. Do not touch the rotary air vents with your hands or other objects to avoid of accidents or damage.
15. It is forbidden placing goods above the machine set, so as not to result in the danger of the fall off when they are running.
16. This appliance is not intended for use by persons (including children) with reduced physical, sensory or mental capabilities, or lack of experience and knowledge, unless they have been given supervision or instruction concerning use of the appliance by a person responsible for their safety.
17. Children should be supervised to ensure that they do not play with the appliance.
18. If the appliance is fixed wiring, the appliance must be fitted with means for disconnection from the supply mains having a contact separation in all poles that provide full disconnection under over voltage category III conditions, and these means must be incorporated in the fixed wiring in accordance with the wiring rules.
19. If the supply cord is damaged, it must be replaced by the manufacturer, its service agent or similarly qualified persons in order to avoid a hazard.
20. If the equipment contains fluorinated greenhouse gas R410A, the value of Global Warming Potential(GWP) is 2087.5.

1. 2 Use notices

1. The unit must be installed in outdoor field where there is sunlitproof and rainproof establishments , or else our company is not responsible for the problems caused because of wrong installation.
2. All the operation parameters of the unit set , the set values of the protective device have been set before the delivery , the consumers are not allowed to change the set values at random , and also are not allowed to make the line of the protective devices of the machine set , short-circuit or the unit may be damaged as result of improper protection.
3. When the unit is running, the unprofessional personnel do not touch any electrical element and buttons, or it will result in serious accident.
4. If the unit goes wrong , don' t repair it by yourself , please consult the service center of the company (the consultation telephone number can refer to the back over). If the machine set is repaired by unprofessional personnel , it may result in the machine breakdown or the casualty of personnel.
5. During cleaning the unit, never clean the operational panel with benzene, diluent agent , or chemical cloth and so on , or it will result into fade or the fault function of the buttons ; It is not allowed to directly sprinkle the unit with water or cleaning agent, when it is necessary, please clean them with a cloth that is stained with water or neutral cleaning agent.
6. In order to prolong the service time of the air- condition, please do not start the compressor frequently. (It should not be more than five times in an hour).
7. The refrigerant used in the machine set is noncombustible and innocuous , as for the specific gravity of which is greater than air , so when it leaks, it will diffuse on the ground. As a consequence, if the unit is installed in a room, it must make sure that the ventilation condition is good , or it way result in serious asphyxia when the refrigerant leaks.
8. If the refrigerant leaks, stop the unit as soon as possible, and get in touch with the maintenance and repairmen in time, the flame on the field is forbidden, because if the refrigerant contacts with the flame, it will decompose into harmful gas
9. Please service the machine set termly according to the requirements of the specification , in order to make sure that the operation condition of the machine set is good.

PARTS NAME AND FUNCTION

■ Indoor unit

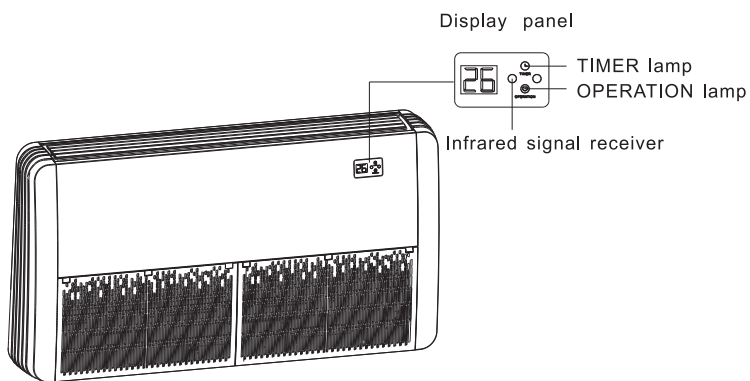

■ Outdoor unit

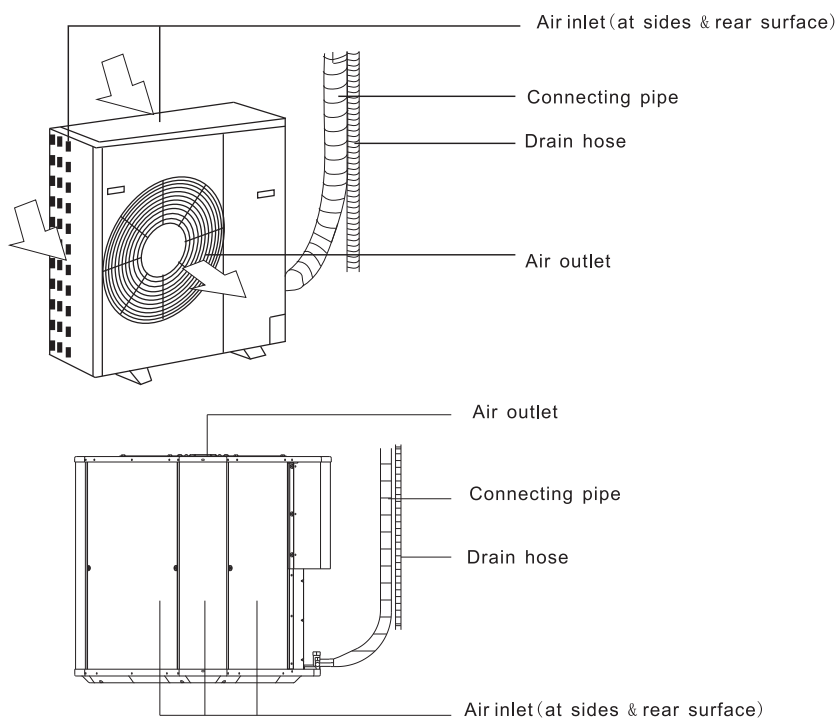

NOTE: The drawings above based on one model of our product is for reference only, which may be different from the unit you purchased.

INTRODUCTION OF REMOTE CONTROLLER

3.1 Instruction for Remote controller

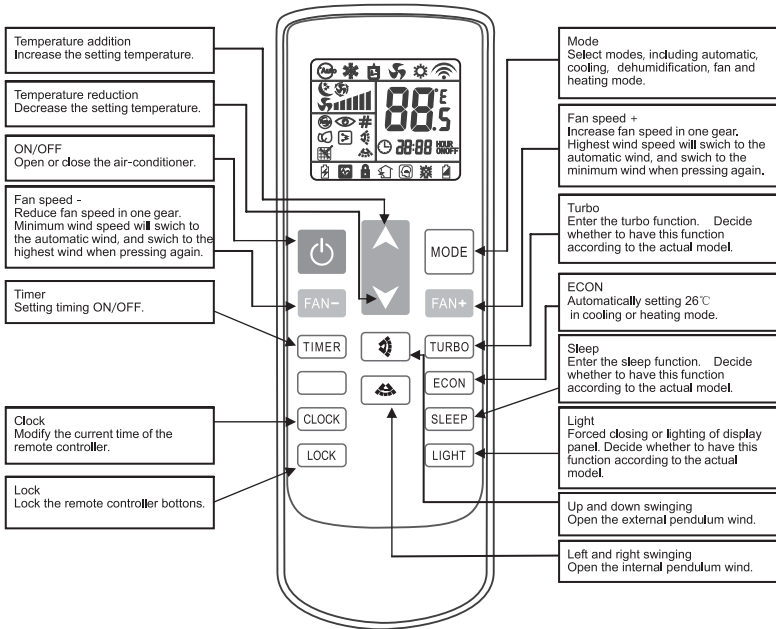

3.2 Introduction of Functional Key

ON/OFF key: When pressing the key, the remote controller circulates in sequence of "ON→OFF→ON".

During OFF→ON for first power on, the default setting of working status (temperature setting 25°C, automatic mode, automatic wind speed, automatic swinging, automatic throttle, without light, without force, without purification, without sleep, without timing, without lock key). During OFF→ON for non-first power-on, the working status is that before power off. The lamp, purification, cancel, forced and timing functions will be canceled after power off.

Mode key: When pressing the mode key, the remote controller will circulate in sequence of "Automatic → Cooling → Dehumidification → Heating → Ventilation → Automatic".

Minus key: When pressing this key in dehumidification mode and automatic mode, the temperature will not change. In other modes, press this key once and the temperature setting will increase by 1 in the sequence of "16°C→17°C→...→31°C→32°C".

Swinging key: In dehumidification mode, the swinging will be fixed and unadjustable. In other modes, when pressing the swinging key, the remote controller will circulate in the sequence of "Swinging wind → fixed direction wind → natural wind → swinging wind".

Wind direction key: The wind direction is set as swinging state in default during first time power on; press this key and it will circulate in sequence of "Swing → Stop → Swing".

Wind speed key: The wind speed is set at automatic wind speed in default during first time power on; in dehumidification mode, the speed wind is fixed as low speed and can not be adjusted; it will have no response when pressing the wind speed key. In other modes, press this key and it will circulate in sequence of "Automatic wind → High speed wind → Medium speed wind → Low speed wind → automatic wind".

Timing key: Set at non-timing state in default; press this key for timing setting in unit of 1 hour in the sequence of "1 H→2 H→...→24 H→ cancellation →1 H...". In power off state, press timing setting key to set power on setting; press timing setting key to set the timing switch in power ON state. After setting of timing function, decrease every 1 hour till reached the setting time when it will power on or off, and cancel the timing display. If the timing is activated, the timing will not be canceled if pressed mode key. If the timing is activated, pressing of other key will send the setting time.

Forced key:The remote controller is set of non-forced state in default; in automatic, dehumidification and ventilation modes, the forced key does no function (no display and no code emitted for force). When pressing this key in other mode, the forced mode will circulate between ON and OFF. The wind speed does not display if the forced mode is activated; the forced mode will be deactivated after switching the mode if it is activated; the forced mode will be canceled when setting the sleep operation.

Sleep switch: When pressing the sleep key, circulate in sequence of "sleep → cancel sleep → sleep"; if the sleep mode is activated, it will not be canceled after changed the mode. When pressing the sleep key to sleep, the wind speed will automatically switch to low speed, but the pressing of wind speed key can adjust the wind speed (except dehumidification mode)

Lock key: It is set as non-lock state in default; when pressing this key, the remote controller circulates in sequence of "Lock→ Cancel lock→ Lock". If the lock key is activated, all keys of remote controller other than lock key does no function. (Note: when the lock key is activated, the keys on cabinet unit remote controller and air conditioner operation panel will automatically lock; when pressing the key again, the remote controller and air conditioner will automatically unlock. In discrete unit, only the remote controller is locked, the emergency button will not be locked, but the main plate response.)

Light key: The split unit only locks the remote controller, but does not lock the emergency lock; the main board will response. It is set as non-lamp state in default; when pressing this key, the remote controller circulates in sequence of "Lamp→Cancel lamp→Lamp". If the lamp key is activated, after pressed the mode key, the lamp key indication will not be canceled.

Purification key: Set as non-purification state in default; when pressing this key, the remote controller will circulate in sequence of "Purification → Cancel purification → Purification". If the purification is activated, the purification will not be canceled after pressing the mode key. When pressing this key in power-off mode of remote controller, it will circulate in sequence of "Purification → Cancel purification → Purification". When open the purification separately during power-off, swing wind is fixed, wind door is unadjustable, wind speed is adjustable .

3. 3 Notices for operating the remote control

- ① Do not place the remote controller near the high temperature heat sources such as electric carpet or heating oven.
- ② Do not put the remote controller at the position directly exposed to the sunshine.
- ③ Be careful not to drop off from high position; otherwise it may be damaged.
- ④ There must have no barrier between signal receiver and remote controller of air conditioner which may affect the receiving and transmitting of signal.
- ⑤ Do not splash the liquid such as water onto the remote controller.
- ⑥ Do not place the weight onto the remote controller.

Note: In case of operation failure of remote controller, please replace with new battery and repeat the operation; if the failure still exists, please run the air conditioner in emergency operation method, and contact the dealer or special maintenance points.

3. 4 Replace batteries of the remote control

In case of following conditions, it indicates the battery is used up; take out the used battery and replace with new one.

- ① There is no air conditioner receiving sound after transmitted the signal.
- ② The display screen becomes obscure.

In case of above conditions, it indicates the battery is used up; take out the used battery and replace with new one.

- A. Remove rear cover and take out the used battery.
- B. Replace the battery; notice the "+" and "-" electrode marks of battery.
- C. Close the rear cover.

Note:

- 1. The new and used batteries must not be mixed.
- 2. Please take out the battery if the remote controller is not used for long time.

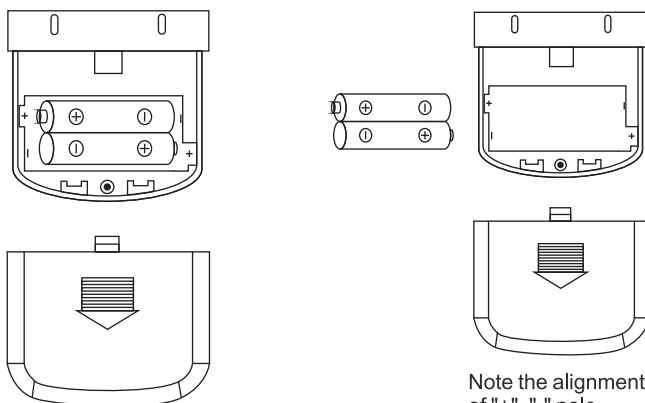

Remove the back cover

Note the alignment of "+" , "-" pole

PREPARATIONS FOR INSTALLATION



CAUTION

The installation of the unit has to be carried out by the professional installation operator. Improper installation of the unit may cause water leakage, an electric shock or fires .

4. 1 Selection of the installation site

4. 1. 1 Installation sites for the outdoor unit

- 1) Installed the unit at the places where not be exposed to rain or not direct sunshine ,and the places with good ventilation.
- 2) Noises made by unit will not affect the neighboring places.
- 3) Easy to connect the units and the power.
- 4) Not install the unit on the non-special metal bracket;
- 5) Not to installed at the places where may leak inflammable gases;
- 6) In heating, pay attention to the drainage of the condensed water from the base plate so that it does not affect the neighbor or passer-by;
- 7) Not locate the exhaust ports pointing the windward direction ;
- 8) Make sure that the children can not touch it ;
- 9) Leave enough space for installation or maintenance, refer to Fig 1;
- 10) The air conditioner is not applicable for the following fields:
 - a. On the vehicle or ship;
 - b. The place with heavy oil or strong wind;
 - c. The moist place, such as bathroom, cellar and so on;
 - d. The place with high-frequency equipment, such as wire-less equipment, electric welder, medical instrument and so on;
 - e. Other special fields.

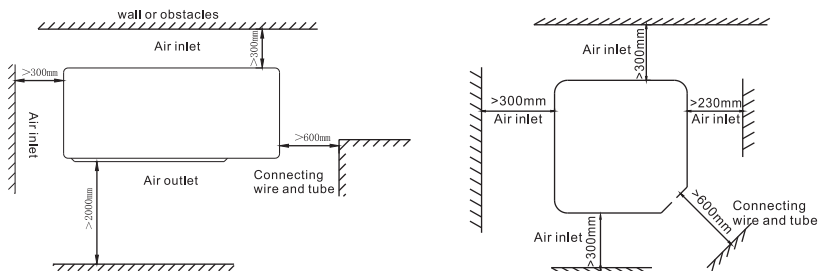

Fig 1

4. 1. 2 Installation sites for the indoor unit

- 1) Keep the unit level and without any vibration and keep supply air to all places in room quickly;
- 2) The air inlet or outlet of the indoor unit can not be blocked so that the supply air or return air is free and not affected by heat or moisture nearby;
- 3) Not install it in the place with too much oil smoke or steam.

- 4) Avoid the place where inflammable gases may generate, inflow, linger or leak .
- 5) Avoid high-frequency facilities (such as high frequency arc welders, etc.).
- 6) Not install the exhaust ports near a fire alarm;
- 7) To avoid the places where acid solutions are frequently used.
- 8) Keep the indoor unit near the power plug or special wires.

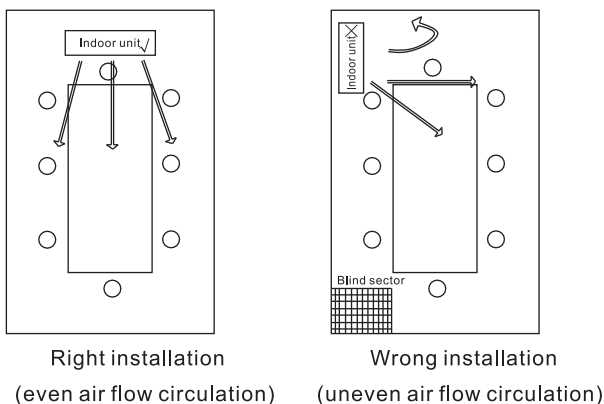

Fig 2

4. 2 Preparation before installation

According to the position and installed dimension to made the base.(Fig 3)

4. 2. 1 Outdoor unit

4. 2. 1. 1 Install the unit on the ground:

■ Concrete foundation

This foundation is cast with the design mark concrete, which has great anti-vibration effect, the following factors shall be emphasized:

- 1) The surface of concrete foundation is massy, firm and flat. The bearing of the support surface is more than 2 times of the unit weight.
- 2) When the cement foundation platform is made , the following measures are adopted: put the whorl reinforcing steel bar (Dia > 9.5 mm)into the concrete foundation, the whorl reinforcing steel bar must be enlaced as top and bottom layers, and the space between bars is 10cm.
- 3) When making the cement foundation on the concrete floor board, please keep the surface coarse, and then clean and wet it, after all of these works, make the concrete foundation seat.
- 4) The mix ratio of the concrete is 1:2:4, if necessary, embed some proper anchor bolts. Finally, keep the surface of the basic platform smooth.
- 5) The surface of the concrete foundation platform should have the waterproof disposal and around of it we should have a drip through and the gradient is more than 30 °, pointing to outfall.
- 6) Until the concrete foundation is fully dry, you can install the unit.

- 7) In order to run the unit quietly and avoid the noise and vibration interference to the surroundings, there should keep a separate layer for vibration-proof between the base of the unit and foundation. And then keep the unit level when installing.
- 8) To avoid units distortion and even rupture, which is caused in displacement of the unit run for a long time, you should take some measures to fix the unit at the restrict position.(Fig3)

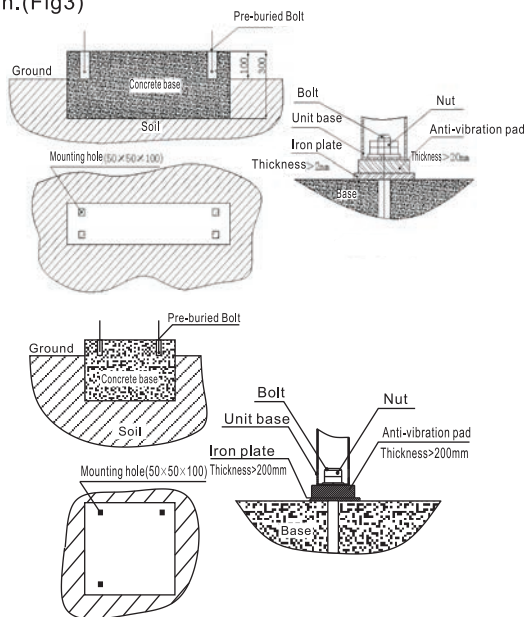

Fig 3



NOTE

- The distance between the concrete foundation and the ground is more than 100 mm;
- The height of the concrete foundation is more than 300 mm;
- The concrete foundation should keep level with the level gradient less than 0.1 %

■ Welded with Channel Steel, I-Steel and Angle Iron, the support should be riveted on the ground with bolts.



NOTE

The support surface must be strong enough to bear unit' s load, and it do not increase vibration and noise, which may cause the disturbance.

4. 2. 1. 2 Install the unit on the wall:

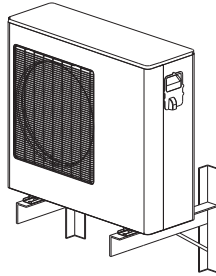
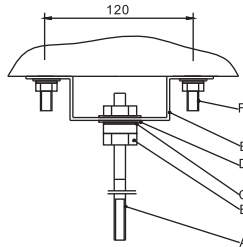

Fig 4

4. 2. 2 Indoor unit

4. 2. 2. 1 Install the unit on the ceiling:



- A:Hanger bolt
- B:Nut
- C:Spring washer
- D:Flat washer
- E:Installation rack
- F:Expansion bolt

Fig 5

4. 3 Unpacking inspection

Inspect the equipment before installation. Do as follows:

- Check for any damage or damp at outer surface after opening.
- Check for name, specification, type of the unit meeting requirement and make sure the user’ s manual , qualification card are complete and the accessories are compliant to the packing list.

■ Checking the unit , refer to Table 1

Table 1

Check item	Content	Check item	Content
UNIT	1) Check if the surface is broken or humid when the packing is open . 2) Check the pipe is ok. 3) Check the accessory is ok. 4)Checkif the gas pressure of unit is OK.	Fan	Check if the fan works well.
PCB	1) check if the PCB is ok. 2) check if the insert accessory is tight. 3) check if the connect of earth wire is tight.	Fan motor	1) Check if insulation is ok. 2) Check if the connect of earth wire is tight. 3) Check if the wire connect of fan motor is tight.

■ Keep check record as Table2

Table 2

Unit name			
Unit inspection	1.Packing		
	2.Unit treatment		
	3.PCB check		
	4.Fan and motor check		
	5.Others		
Inspection on technical cocuments	1.Packing lisk	copy	pcs
	2.Qualified card	copy	pcs
	3.User' s manual	copy	pcs
	4.Others	copy	pcs
Problem and treatment			
Inspector	Year	Month	Date

4. 4 Check the power of the unit

- Before installing the unit, must check the specifications of power capacity, power cord and switch, to ensure the unit accord with secure request.
- The power of the unit should be connected with the special power switch with leakage protection function.



NOTE

If the request above is not met, the installer must refuse to install the unit.

INSTALLATION OF THE UNIT

5. 1 Install indoor units and outdoor units

5. 1. 1 Install outdoor units

- 1) Fix the unit on foundation and adjust it to level with the gradient.
- 2) Fix the unit on the base with nuts and then tighten them.
- 3) Fix the unit firmly enough to withstand vibration or strong wind.
- 4) When mounting the unit on the wall with the bracket, please refer to the installation of Household Air conditioner.
- 5) Adopting the concrete foundation, please refer to Fig 6:

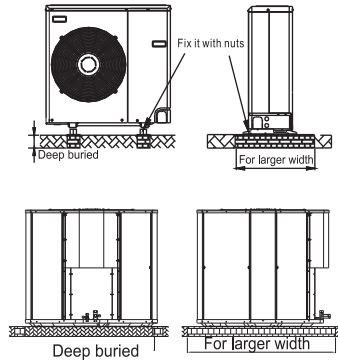

Fig 6



NOTE

- Transit the unit with the package to the installation field.
- The gradient is not over 20° when transiting the unit.

5. 1. 2 Install indoor units

5. 1. 2. 1 Install M10 hanging screw bolts. (4bolts) :

- Please refer to the following figure for the distance measurement between the screw bolts.
 - Please install with M10 hanging screw bolts.
 - The handling to the ceiling varies from the constructions, consult the construction personnel for the specific procedures.
- 1) The size of the ceiling to be handled. . . do keep the ceiling flat. Consolidate the roof beam for possible vibration.
 - 2) Cut off the roof beam.
 - 3) Strengthen the place cut off and consolidate the roof beam.
- Carry out the pipeline operation in the ceiling after finishing the installation of the main body. While choosing where to start the operation, determine the direction of the pipes to be drawn out. Especially in case of there is a ceiling, position the refrigerant pipes, drain pipes, indoor & outdoor lines to the connection places before hanging up the machine.
 - The installation of hanging screw bolts

■ **Wooden construction**

Put the square timber cross the roof beam, then install the hanging screw bolts (Refer to Fig 7)

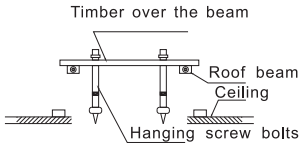

Fig 7

■ **New concrete bricks**

Inlaying or embedding the screw bolts (Refer to Fig 8)



Fig 8

■ **For Original concrete bricks**

Use embedding screw bold, crock and stick harness (Refer to Fig 9)

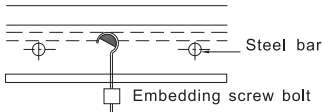

(Pipe hanging and embedding screw bolt)

Fig 9

■ **Steel roof beam structure**

Install and use directly the supporting angle steel (Refer to Fig 10)

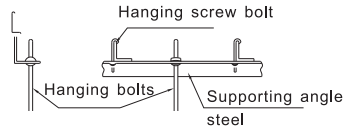

Fig 10

5. 1. 2. 2 Wall Mounting Installation

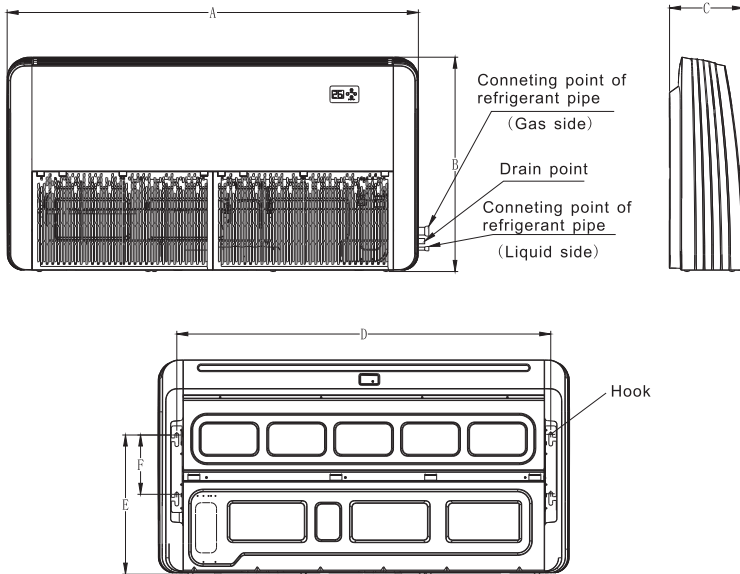

Fig 11

- Fix the hook with tapping screw onto the wall (Refer to Fig 12)
- Hang the indoor unit on the hook

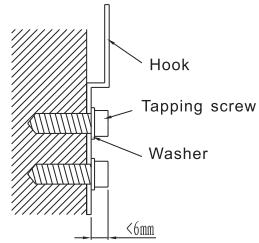

Fig 12

5. 1. 2. 3 Ceiling Installation

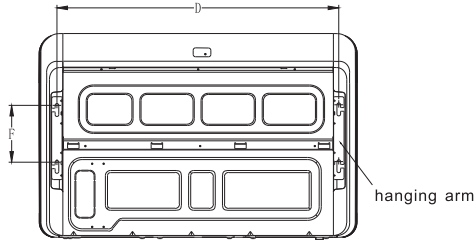

Fig 13

- Remove the side board. (Refer to Fig14)

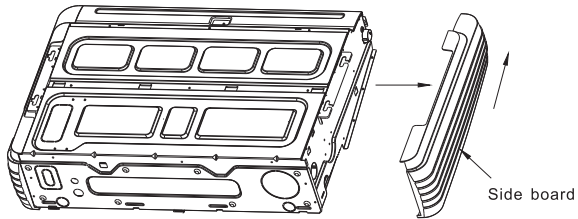

Fig14

- Locate the hanging arm on the hanging screw bolt (Refer to Fig15)

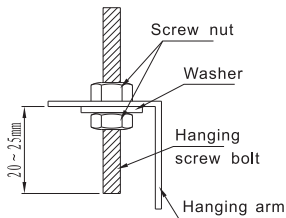

Fig15

■ Hang the unit on the hanging arm by sliding backward. Securely tighten the mounting bolts on both sides (Refer to Fig 16)

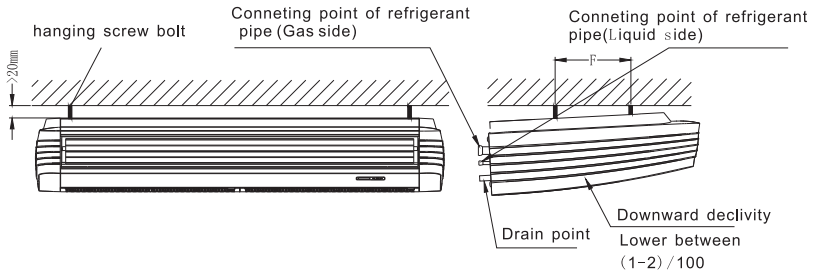

Fig 16

5. 1. 2. 4 The dimension of the unit

Table 3

Model (kBtu/h)	A(mm)	B(mm)	C(mm)	D(mm)	E(mm)	F(mm)
18~24	1050	675	235	933	440	188
36	1300	675	235	1185	440	188
48~60	1670	675	235	1553	440	188

5. 2 Install and connect refrigerant pipes

After installing the indoor and outdoor unit, you can connect the pipes.

5. 2. 1 Inspection of pipes

Before connecting pipes, inspect pipes so that the following requirement is met;

- The inside of the pipe is clean, no dust, air or water gathers in the pipe;
- Flares and nuts at both ends of the pipe are in good condition.

Bend the refrigerant pipe following the scheduled routine. During bending pipes, avoid the pipe broken or out of shape and keep the bent radius of the copper pipe as big as possible (400mm at least) and the bent number no more than 3 times.

5. 2. 2 Connection of pipes

As connecting the refrigerant pipes for indoor units, the operation must be rapid to make sure that the time for connecting two pipes is not too long at site.

5. 2. 2. 1 When connecting the flared connector, keep two pipes aligned with the same center and then put on the screw nut and revolved them in. Finally, tighten the screws with wrenches, refer to the figure below:

Please fix the copper with wrenches in proper torque force according to Table 4 Torque Force Table.

Table 4

Diameter of copper pipe ϕ (mm)	Tightening torque(kgf · m)
6.35	1.4~1.7
9.52	1.4~1.7
12.7	4.8~6.2
15.88	4.8~6.2
19.05	6.9~9.9

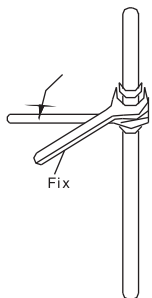

Fig 17

NOTE: Please use two wrenches, normal wrench and torque wrench.

5. 2. 2. 2 Drill through the wall:

The pipe and wire should be protected with the sleeve when it drills through the wall.(Fig 18)

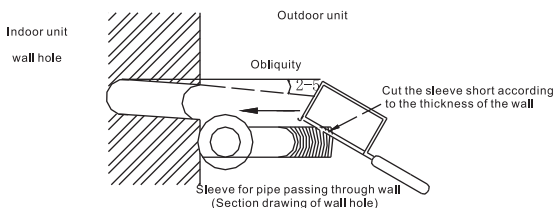

Fig 18

5. 2. 2. 3 Exhaust the air in connecting pipeline:

■ If the connection pipe is no more than 5 meters, use refrigerant in outdoor unit to exhaust the air(50-100 g refrigerant is charged for emptying the pipe before the outdoor unit is delivered, refer to Fig 19).

- ① Srew down the nuts at A, B, C, D joint completely.
- ② Turn on the nut of the Valve B with the hexagon wrench and then turn the valve core 45° anti-clockwisely for 10 seconds with the inner-hexagon wrench, then tighten the union A.
- ③ Have the leak test at A, B, C, D joint and then press the core of Valve A to exhaust the air for 20 seconds and then screw down the service valve.
- ④ Open Check valve B and A completely with the inner-hexagon wrench, then tighten nuts of them.

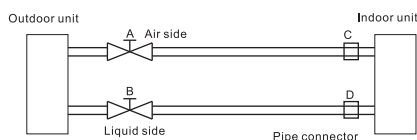

Fig 19

■ When connect pipe length over 5 meters(single distance),use vacuum pump to exhaust the air ; As for the unit utilizing R410A, it must use vacuum pump to exhaust the air no matter how long the pipe is . (Refer to Fig 21)

- ① Open Nut A, connect Charging hose 1 of the manifold to valve A (Valve A and B must be turned off). Then connect Charging hose 2 to the vacuum pump.
- ② Open Low pressure handle of the manifold Lo complete.
- ③ Start the vacuum pump to exhaust the air. Open valve B a little to check whether the air come in or not.(The noise from vacuum pump changes and the reading of gauge alters from negative to zero),and then tighten the valve nut.
- ④ After exhausting the air, close Low pressure handle of the manifold (Lo) completely.

NOTE: Exhaust the air over 15 minutes and ensure the multimeter show “-1.0x105Pa” (-76cmHg).

- ⑤ Take down Charging hose at A joint, then tighten the nut.
- ⑥ Unscrew the nuts of valve A and B and turn on Valve A and Valve B, then tighten their nuts.

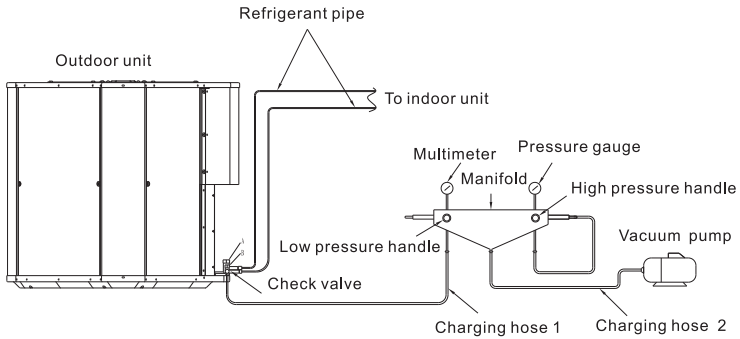

Fig 20

5. 2. 2. 4 Air leakage test: Water soap suds to connectors and joints of valves to check whether there is any leakage at the joints.

5. 2. 2. 5 Heat preservation: After leakage test and pressure test, wrap the pipe with the insulating material .Request of the insulation layer.

- Insulation layer of pipeline should be 8 mm at least and wrapped up tightly.
- Process the surface of the insulation lay for waterproof and moisture-proof (usually wrap the pipe with the bend).
- It is not allowed for the surface with dew when the unit is in cooling mode.

5. 2. 2. 6 New tools for R410A

Table 5

New tools for R410A	Changes
Gauge manifold	If the working pressure is quite high, it is impossible to measure the pressure with the conventional gauge. In order to prevent any other refrigerant from being charged, the diameter of the port should be changed.
Charge hose	In order to improve the pressure resisting performance, the hose material and the size of the hose should be changed (1/2 UNF thread, 20 threads per inch). When purchasing the charge hose, please confirm the size.
Multi-meter	When the working pressure is quite high and the gasification speed is fast, it's difficult to read the indicated value for using the charging cylinder.
Torque wrench (Nominal Diameter: 1/4, 3/8)	The size of the opposing flare nut is increased. Besides, the common wrench is applicable for the case: The nominal diameter of the port is 1/4 or 3/8.
Flare tool(clutch type)	Increasing the size of hole in the clamp bar can increase the force of the drift punch of the flare tool.
Cut pipe	Used when making the flare with the conventional flare tool.
Vacuum pump adapter	Connected to the conventional vacuum pump, the adapter can prevent the oil of the vacuum pump flowing back to the charge hose. The charge hose has two ports: one for the conventional refrigerant (7/16 UNF thread, 20 threads per inch) and the other for R410A. If the oil of the vacuum pump is mixed with some R410A, the sludge will be produced, which will do damage to the equipment.
Gas leakage detector	Exclusive for the refrigerant HFC



NOTE

- The refrigerant cylinder comes with the refrigerant designation (R410A) and the specified color of the protector coating is rose in the ARI (ARI color code: PMS 507).
- The charge port of the refrigerant cylinder is 1/2 UNF thread, that is 20 threads per inch, subjected to the diameter of the charge hose.

5.3 Tubing for pipeline

Because of the installation position and the pipeline length of the is differ, please select proper pipe and the installation position where can keep the pipe as short as possible. During collocating the pipe, please pay attention to the following items:

■ Maximal distance of pipeline

Table 6

Cooling capacity(kBtu/h)	18	24~60
Max length(m)	15	20
Max height(m)	8	10
Max elbow(pcs)	5	8

NOTE: The above parameters fully consider the loss of refrigeration output and oil return while ensuring 80% refrigeration output.

■ The use of oil loops

When the height difference between indoor and outdoor units is relatively large, oil loops should be used to facilitate for oil return. Please refer to the following typical mounting methods in Fig 21

1) Height difference of indoor and outdoor unit is over 5 meters:

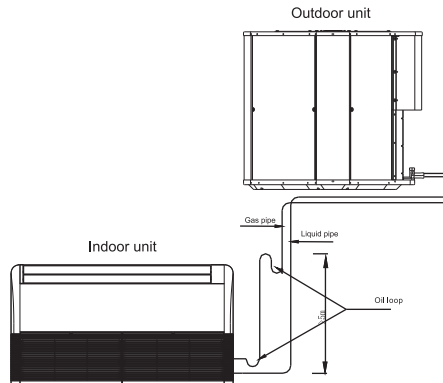

Fig 21

NOTE: Cooling only unit does not adopt oil loops.

2) When height difference of indoor and outdoor unit is less than 5 meters, it will take normal way to install them.

■ Adding refrigerant

Add refrigerant when the connecting pipes are longer than 8 meters, as Table 7:

Table 7

Diameter of liquid pipes(mm)	Adding amount per meter(g)
Φ6.3	30
Φ9.5	65
Φ12.7	120

NOTE: when adding refrigerant, the running air return pressure must be 4.5-5.5kgf/cm².

5. 4 Install condensate pipes

As for Floor ceiling unit, there are two ways in installing the drain pipe :

5. 4. 1 When installation place is near the drain off, it will adopt the installing method of House-hold air conditioner;

5. 4. 2 When installation place far from the drain off:

■ You can select U-PVC as the pipeline material;

■ Request of installation

- a. Set water seal in outdoor water spout and then fix it up.
- b. The gradient of drain pipe is no less than 1° and there is no bent for this section .
- c. Indoor part of condensate pipe should be wrapped with heat-preservation material to avoid of generating dew, so do the joint of the indoor unit;
- d. If the drain pipe is quite long, please set supports to protect the pipe from bending.
- e. After installing the condensate pipe, it will do leakage test through pouring some water to check whether there is a leakage at joints and drain is smooth. As for the new room, do the leakage test before laying the ceiling, please refer to Fig 22.

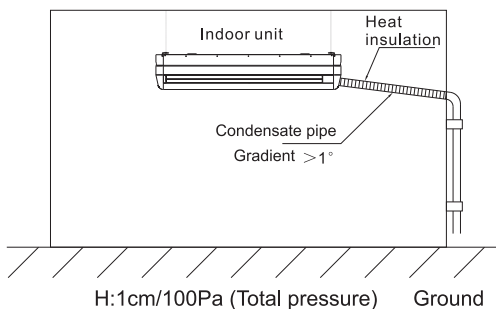

Fig 22

SYSTEM CHECK AND TEST RUN

6. 1 Check the air conditioner

Before test running, please check the units according to the following items.

- Check whether the indoor and outdoor units have been installed right .
- Check whether the tubing and wiring has been right .
- Check all the joints of the refrigerant pipeline with gas leak detector.
- Check whether the drain is smooth.
- Check whether the heat preservation layer is in good condition.
- Check whether the machine is properly grounded .
- Check the voltage of power supply (Make sure the voltage is within rate limit) .
- Check whether there is any obstacle in the inlet and outlet vents of indoor and outdoor units .
- Open the liquid side and air side check valve .

If all cases above are OK, you can begin to carry on the test run.

6. 2 Test run and debugging

Turn on the unit in cooling mode by remote controller and then check following items.

6. 2. 1 Indoor unit

- Check if ON/OFF key or functional keys on the remote controller work well .
- Check if the air guide board is running normally.
- Check if all lamps are all right.
- Check if the drain is smooth .
- Check if there is any abnormal noise or vibration during operating.
- Check if the units runs normally in heating mode for heat pump type unit.

6. 2. 2 Outdoor unit

- Check if there is any abnormal noise or vibration during operation .
- Check if the noise, wind and drain water from the units disturb the neighbors.
- Check if there is leakage of refrigerant .

6. 3 Check and accept

If the debugging and test run are OK, tide up the information and deliver to users.

- The preparation of information includes(refer to Table 6 and Table 7):
 - 1) The checking records of unpacking the equipment, the certificate of qualification of all equipments;
 - 2) Debugging records ;
- Fill the guarantee card

Test run and debugging records

Table 8

Project name	
Debugging date	
Debugging content	
Debugging results	
Opinions	
Personnel	

The record of checking and accepting the completion

Table 9

Project name		Project site	
Completion date		Delivery date	
Content			
Checking information			
Checking opinions			
Note			
	Year	Month	Date
	Representation for users		Year
	Month	Date	

NOTE: The tables above are just for a reference other than a standard of checking and accepting for the completion.

MAINTENANCE AND UPKEEP

7. 1 Before maintenance

- Turn off the air conditioner and pull out the plug .
- Do not clean the air conditioner with water .

It might cause electric shocks , please use a soft and dry cloth to clean the air conditioner .

- Do not use the following substances :

- 1) Hot water(over40°C): The hot water will deform the air conditioner or make it fade in color .
- 2) Gasoline, paint diluent ,benzene and polishing agents, etc. These substances will deform the air conditioner .



CAUTION

If the air strainer is blocked by dust or dirt ,the performance of cooling and heating will be affected, with the operation noise and power consumption increased. Therefore, please clean the air strainer regularly .

7. 2 Maintenance after a long stop period

(eg. at the beginning of the season)

- Check if there are any obstacle in the intake and outlet vents of the indoor and outdoor units .
- Check if the installation base is corroded or rusty .
- Check if the machine is properly grounded .
- Check if the air filter is clean .
- Turn on the power source .
- Put batteries in the remote controller .

7. 3 Maintenance during operation season

Clean the air strainer(Normal intervals is once every two weeks).

- Take down the air strainer;
- Clean the air strainer .

If the strainer is very dirty, please clean it with lukewarm water (about 30°C) and then air it.



CAUTION

-
- Do not use boiling water to clean the screen .
 - Do not bake the screen dry over a fire .
 - Do not draw it forcibly .

- Install the air strainer .

To operate the air conditioner without the air strainer, which will accumulate some dirt in the interior of the machine so that it will get the poor performance even damage the units .

- Clean the air conditioner

- 1) Use a soft and dry cloth to rub the air conditioner ,or use a vacuum cleaner to clean it .

- 2) If the air conditioner is very dirty ,use a piece of cloth and soak it with neutral home-use detergent to clean it .

7. 4 Maintenance before a long stop period

(eg. at the end of the season)

- Set the temperature at 30°C and make it run in cooling mode for about half a day .(To dry theinterior of the units)

- Stop the machine and cut off the power. Usually, the air conditioner will consume about 5W electric energy even through the machines is turned off. For saving energy and safety, please pull out the plug if you do not use the air conditioner.

- Clean and install the air strainer.

- Clean the indoor and outdoor units.

- Take out the batteries from the remote controller .

TROUBLESHOOTING

8. 1 Malfunction analysis

If the following cases happen, do not worry, for them being not faults:

Phenomena	Phenomena analysis
The air conditioner can not be restarted just after shutting down	The unit delays running for 3 minutes after stopping for protection. The three-minute protection timer built-in micro-computer works automatically, but it is not for the case when the unit is powered first time.
The air conditioner does not supply air at the beginning of heating.	The air conditioner does not supply air to avoid of blowing cold air until the indoor heat exchanger is warm(2-5minutes).
The air conditioner does not supply air after it has running for 5-10 minutes in heating mode.	The air conditioner enters defrost mode automatically when the outdoor temp. Is quite low or the humidity is too high, so please wait for a moment. Besides, during defrosting, some moisture or steam will come out from the outdoor unit.
The air conditioner does not supply air in dehumidifying mode.	Sometimes, the fan of indoor unit will stop running to prevent the condensate from evaporating and save energy.
The air conditioner blows out the moisture in cooling mode.	This is caused by too high temperature and humidity of the room. It will eliminate when the temperature and humidify reduces.
The air blown out is smelly.	The air blown out is smelly during operating, it may come from the tobacco or other cosmetics stucked to the inner of the air conditioner.
Squeak is heard from the unit	This is caused by the circulating refrigerant inside the unit.
Crack is heard from the unit	This is caused by heat expansion or contraction of plastics
When the power restores, the air conditioner can not run	This is because the memory circuit of the microcomputer is cleared. Please start the air conditioner through the remote controller.
The air conditioner can not receive the signal from the remote controller.	It may happen when the signal receiver of the air conditioner is exposed to sunlight or strong light directly or the batteries are used up. In that case, eliminate those factors or change the batteries.
There is some drop on the air outlet and the grille.	The air outlet and the grille moisture will condense when the air conditioner is operated in humid environment for a long time, please adjust the grille and the vane to the position which is in parallel with the wind supply direction and select "High speed" mode to improve the condensing phenomena.

Pull out power plug immediately and inform to your distributor in the following situations:

1. Fuse or breaker often breaks off .
2. Power wires are excessively hot .
3. Covering of power wires is broken .
4. Switch works well.
5. Abnormal noise is heard during operation .

8.2 Self-fault diagnostic function

Our company will provide convenient service to our customers, and install all kinds of judgment systems, which can display the unmoral function of the unit .

Indoor fault codes table

4LED Faults	Digital display	Failure description
Timer light flashing	E2	Ambient temperature sensor (T1) failure
Running light flashing	E3	Evaporator pipe temperature sensor (T2) failure
Defrost light flashing	E5	Condenser pipe temperature sensor (T3) failure
Warning light flashing	F5	Water fullfilled protection
Running light, defrost light flashing	E1	Indoor unit and wire controller communication failure
Running light, timer light flashing	P6	Indoor unit EEPROM failure
Defrost light, timer light flashing	F0	Indoor fan stall protection (DC Motor)
Defrost light, warning light flashing	F2	Outdoor protection (220V Communication control)
	F7	outdoor unit over-current protection (Reserve)
Timer light, warning light flashing	E0	Indoor unit and outdoor unit communication failure (RS485 Communication control)
Running light, defrost light, timer light flashing	F3	High pressure protection (RS485 Communication control)
Defrost light , timer light, warning light flashing	F4	Low pressure protection (RS485 Communication control)
Running light, timer light, warning light flashing	F8	Outdoor unit exhaust temperature over-high protection (RS485 Communication control)
Running light, defrost light, timer light, warning light flashing	F9	Three-phase electricity phase sequence failure (RS485 Communication control)
Note: the flashing frequency for all above indication lights is 1HZ.		

Outdoor fault codes table(1) (Only the green- light)

Faults	LED
High or low pressure failure	Green light flashes once every 5s
Temperature sensor T3 failure	Green light flashes 2 times every 5s
Overflow test failure	Green light flashes 3 times every 5s
Phase sequence test failure	Green light flashes 4 times every 5s
Exhaust temperature over-high failure	Green light flashes 5 times every 5s
Exhaust temperature sensor failure	Green light flashes 6 times every 5s

Outdoor fault codes table(2) (The two light -Green and Yellow)

Faults	LED
High pressure failure	Green light flashes once every 5s
Temperature sensor T3 failure	Green light flashes 2 times every 5s
Overflow test failure	Green light flashes 3 times every 5s
Phase sequence test failure	Green light flashes 4 times every 5s
Exhaust temperature over-high failure	Green light flashes 5 times every 5s
Low pressure failure	Green light flashes 6 times every 5s
Outdoor fan stall protection (DC Motor)	Green light flashes 7 times every 5s
Normal communication receiving	Yellow light keeps constant on
No communication receiving	Yellow light extinguishes
Communication failure warning	Yellow light flashes

Following cases are not air conditioner troubles

1. Sometimes, air conditioner may give off odours, for the unit can absorb the smell of rooms, furniture, cigarettes, makeup, etc., and then emit it again.
2. A continuous low hissing sound is heard when the system is in operation. This is the sound of refrigerant gas flowing through both indoor and outdoor units.
3. When starting up or stopping the air conditioner, you can hear “cracking” sound from the air conditioner, this sound is produced by the contraction or the expansion of the structural part of the air conditioner, which is caused by temperature change.

ELECTRIC WIRING

9. 1 Electric wiring construction

9. 1. 1 Electric wiring precaution

- The unit must adopt the special power, matching with a breaker with the electric leakage protection function;
- Make out the voltage and the spec. of wires before wiring;
- Take care of the clew on the terminal board to avoid wrong wiring;
- Never connect the signal ports of indoor unit and outdoor unit with the power, otherwise, it may cause badly accidents;
- Pay attention to the polarity of the terminal board and the terminal codes;
- Have electricians wiring power wires according to local regulations of the power department and the device standard;
- If the power cable is broken, please contact with our service department for special soft wires;

9. 1. 2 Connect the wires of indoor unit

- Take down the cover of indoor electric box and the clamping board of the trunkings;
- Connect power wires and signal wires to the corresponding ports according the electric wiring diagram;
- Open the clamp and then fix power wires and signal wires on the clamping board;
- Put on the clamping board and then fit on the cover of the electric box.

9. 1. 3 Connect the control lines of indoor unit and outdoor unit

- Connect wires of indoor unit and outdoor unit;
- During wiring, please consider the environment conditions, such as environment temperature, the temperature for direct sunlit and direct sunlit;
- The diameter of wires is the minimum of the metal core wires. But considering the loss of the voltage, adopt the power wire that is larger than ones with the smallest diameter;
- Connect the grounding wires to the unit.



CAUTION

The units listed in the table are Commercial air conditioners, which are not collocated with power wires and wires for connecting indoor unit and outdoor unit.

If the unit is located outdoor, please adopt the power wires which are not less than Chloroprene rubber armored cord(Number 57 wire of IEC 60245). There is no further notify for modifying the spec.

Above, please refer to the parameters on the fitting box.

9.2 Power wiring diagram

Examples of 220V Communication control units:

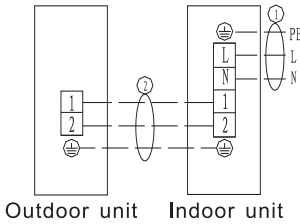

Outdoor unit Indoor unit
Applicable for <24k cooling only type

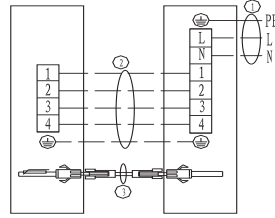

Outdoor unit Indoor unit
Applicable for <24k heatpump type

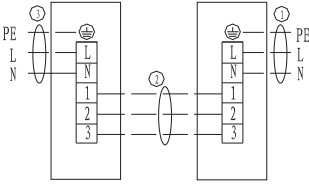

Outdoor unit Indoor unit
Applicable for $\geq 18k$ single-phase cooling type

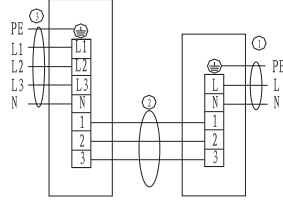

Outdoor unit Indoor unit
Applicable for $\geq 24k$ three-phase cooling type

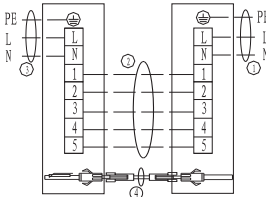

Outdoor unit Indoor unit
Applicable for $\geq 18k$ (haven't outdoor unit E-parts board) single-phase heatpump type

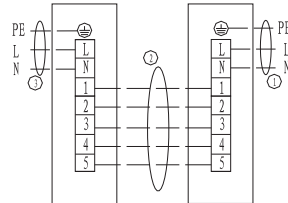

Outdoor unit Indoor unit
Applicable for $\geq 24k$ (have outdoor unit E-parts board) single-phase heatpump type

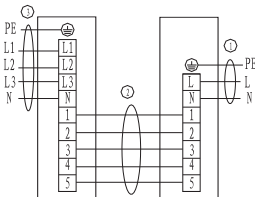

Outdoor unit Indoor unit
Applicable for $\geq 24k$ three-phase heatpump type

Examples of RS485 Communication control units:

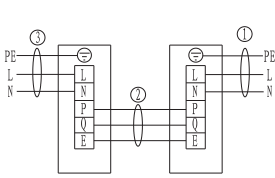

Outdoor unit Indoor unit

Applicable for $\geq 24k$ single-phase cooling and heatpump type

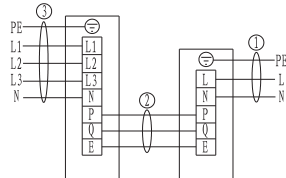

Outdoor unit Indoor unit

Applicable for $\geq 24k$ three-phase cooling and heatpump type

Examples of 24V Communication control units:

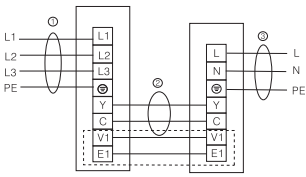

Outdoor unit Indoor unit

Applicable for $\geq 24k$ three-phase cooling type

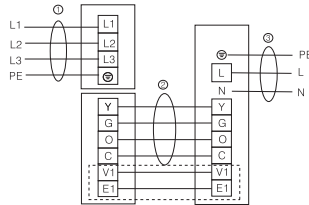

Outdoor unit Indoor unit

Applicable for $\geq 24k$ three-phase cooling and heatpump type

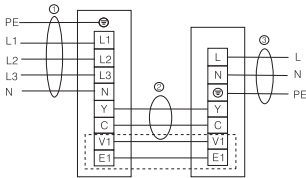

Outdoor unit Indoor unit

Applicable for $\geq 24k$ three-phase cooling type

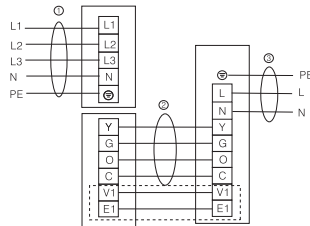

Outdoor unit Indoor unit

Applicable for $\geq 24k$ three-phase cooling and heatpump type

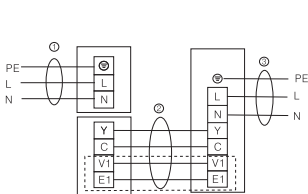

Outdoor unit Indoor unit

Applicable for $\geq 24k$ single-phase cooling type

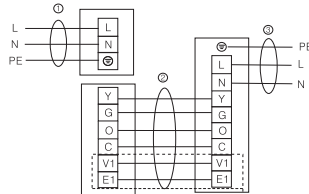

Outdoor unit Indoor unit

Applicable for $\geq 24k$ single-phase cooling and heatpump type

Showing the part chosen in the actual installation

9. 3 Power Wires Spec. Table

Items Model (kBtu/h)	Outdoor power wires	Indoor power wires	220V Signal cables	Power supply types
18k series (Cooling & heatpump)	/	3 x 4mm ²	5 x 2.5mm ²	Indoor units supply
18k (Cooling only)	/	3 x 4mm ²	3 x 2.5mm ²	Indoor units supply
24k series (single-phase)	3 x 2.5mm ²	3 x 1.0mm ²	Cooling only: 3 x 0.75mm ² Cooling & heatpump: 5 x 0.75mm ²	Outdoor and indoor units supply separately
30-48k, series (single-phase)	3 x 4.0mm ²	3 x 1.0mm ²		
30-36k series (three-phase)	5 x 1.5mm ²	3 x 1.0mm ²		
60k series (single-phase)	3 x 6.0mm ²	3 x 1.0mm ²		
48-60k series (three-phase)	5 x 2.5mm ²	3 x 1.0mm ²		

Items Model (kBtu/h)	Outdoor power wires	Indoor power wires	RS485 Signal cables	Power supply types
24k series(single-phase)	3 x 2.5mm ²	3 x 1.0mm ²	RS485 twisted shielded wire pair	Outdoor and indoor units supply separately
24k series(single-phase with electric heating)	3 x 2.5mm ²	3 x 2.5mm ²		
30-48k series (single-phase)	3 x 4.0mm ²	3 x 1.0mm ²		
30-36k series (three-phase)	5 x 1.5mm ²	3 x 1.0mm ²		
60k series (single-phase)	3 x 6.0mm ²	3 x 1.0mm ²		
48-60k series (three-phase)	5 x 2.5mm ²	3 x 1.0mm ²		

Items Model (kBtu/h)	Outdoor power wires	Indoor power wires	24V Signal cables	Power supply types
24k series Single cooling (single-phase)	3 x 2.5mm ²	3 x 1.0mm ²	Cooling only: 4 x 0.75mm ² Cooling & heatpump: 6 x 0.75mm ²	Outdoor and indoor units supply separately
24k series Cooling and heat pump(single-phase)	3 x 2.5mm ²	3 x 1.0mm ²		
36k series Single cooling (single-phase)	3 x 4.0mm ²	3 x 1.0mm ²		
36k series Single cooling (three-phase 220V)	4 x 2.0mm ²	3 x 1.0mm ²		
36k series Cooling and heat pump(single-phase)	3 x 2.5mm ²	3 x 1.0mm ²		
36k series Cooling and heat pump (three-phase 220V)	4 x 4.0mm ²	3 x 1.0mm ²		
48k series Single cooling (single-phase)	3 x 5.0mm ²	3 x 1.0mm ²		
48k series Cooling and heat pump (three-phase 220V)	4 x 3.0mm ²	3 x 1.0mm ²		
48k series Single cooling (three-phase 380V)	5 x 2.0mm ²	3 x 1.0mm ²		
48k series Cooling and heat pump (three-phase 380V)	5 x 2.0mm ²	3 x 1.0mm ²		
60k series Single cooling (three-phase 220V)	4 x 4.0mm ²	3 x 1.0mm ²		
60k series Cooling and heat pump (three-phase 220V)	4 x 4.0mm ²	3 x 1.0mm ²		
60k series Single cooling (three-phase 380V)	5 x 2.5mm ²	3 x 1.0mm ²		
60k series Cooling and heat pump (three-phase 380V)	5 x 2.5mm ²	3 x 1.0mm ²		
60k series Single cooling (single-phase)	3 x 6.0mm ²	3 x 1.0mm ²		
60k series Cooling and heat pump(single-phase)	3 x 6.0mm ²	3 x 1.0mm ²		

Note1:

1. The cable diameter of above mentioned models are based on 6.3m cable length. If the length is increased, please increase the cable diameter accordingly.
2. The cable specs of above mentioned models are based on T1 condition. If used in T3 condition, please increase the cable diameter accordingly.

Note2:

1、 For 30K(single -phase),according to sub-clause 4 of the standard IEC 61000-3-11:2000, we choose to declare that the EUT complies the standard IEC 61000-3-11:2000 provided that the EUT is connected only to a supply of impedance equal to or less than the $Z(Z = 0.092 \text{ Ohm} + j 0.058 \text{ Ohm})$ calculated . The Z_{max} values shall be declared in the equipment instruction manual, which shall also instruct to determine in consultation with the supply authority if necessary.

2、 For 36K(single -phase),according to sub-clause 4 of the standard IEC 61000-3-11:2000, we choose to declare that the EUT complies the standard IEC 61000-3-11:2000 provided that the EUT is connected only to a supply of impedance equal to or less than the $Z(Z = 0.074 \text{ Ohm} + j 0.046 \text{ Ohm})$ calculated . The Z_{max} values shall be declared in the equipment instruction manual, which shall also instruct to determine in consultation with the supply authority if necessary.

ZenAire